

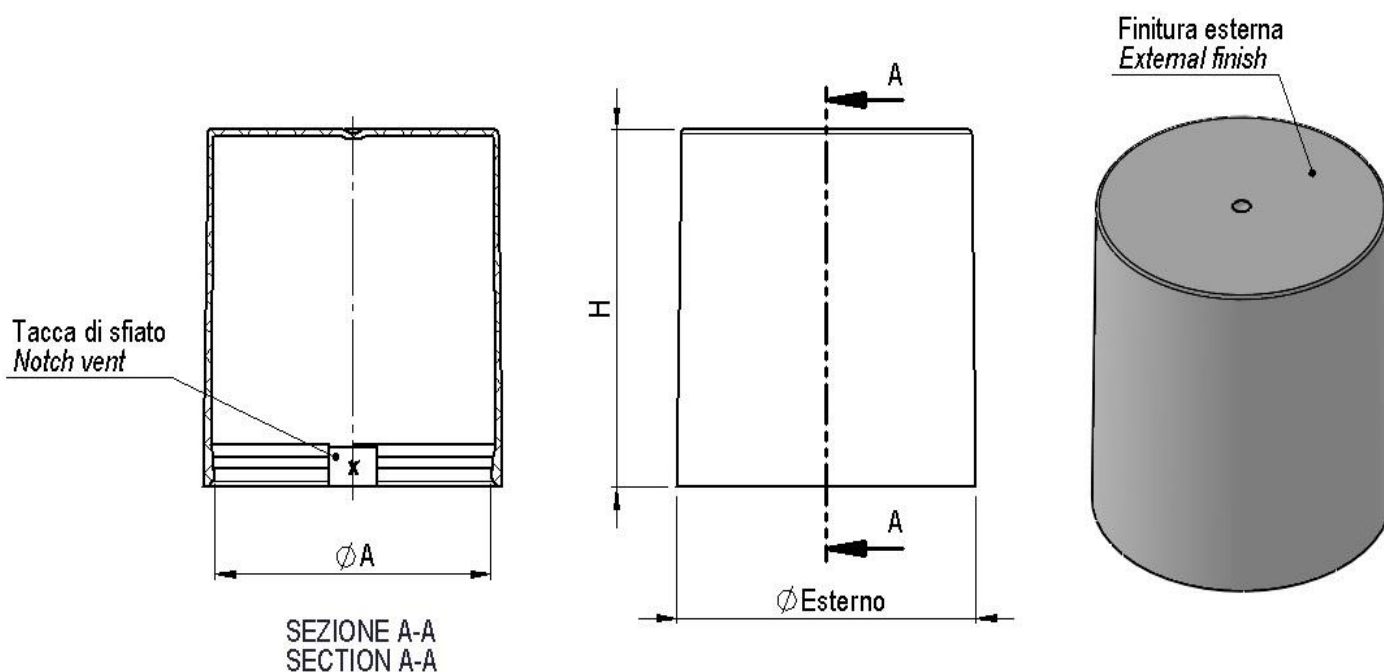





**Art. cod. CPG00881**  
**Descrizione / Description**  
**Capsula a Gorge**  
**Gorge cap**

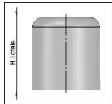

**Tabella dati tecnici / Technical data table**

					
Ø Esterno (mm) <i>External Ø (mm)</i>	Altezza H (mm) <i>Height H (mm)</i>	Ø Aggancio A (mm) <i>Ø Engagement A (mm)</i>	Finitura esterna <i>External finish</i>	Materiale <i>Material</i>	Peso (g) <i>Weight (g)</i>
49,6	55,0	45,75	Lucida/Glossy Satinata/Satin	PP 5	9,50 ±0,30

Il peso indicato è puramente indicativo e non valido ai fini CONAI.  
 The weight indicated is purely indicative.

## Tabella dati imballaggio-spedizione / Table packing and shipping details

Scatola standard (cm) <i>Standard box (cm)</i>	Sacchetto <i>Bag</i>	Quantità per scatola <i>Pcs box</i>	Quantità per pallet <i>Pcs pallet</i>	Pallet (cm) <i>Pallet (cm)</i>
60x40 H:33,5	PE Food contact	400	4800	120x80 H:112



## Stoccaggio / Storage

Conservare i prodotti nella loro confezione originale in un luogo pulito, fresco e asciutto.  
*Store the products in their original packaging in a clean, cool and dry place.*

Temperatura / Temperature : **5÷30°C**

Umidità / Humidity : **45÷75%**

Conservare i prodotti a temperatura ambiente (**20°C±5**) per **48 ore** prima dell'uso sulla macchina confezionatrice.  
*Store the products at room temperature (**20°C±5**) for **48H** before using on packaging machine.*